

DAIKIN ROOM AIR CONDITIONER

OPERATION MANUAL

INVERTER

English

Français

Español



MODELS

FTXS09JEVJU

FTXS12JEVJU

FTKS09JEVJU

FTKS12JEVJU

Feature

For your comfort and energy saving



ECONO

This function enables efficient operation by limiting the maximum power consumption. It is useful when using the air conditioner and other electrical devices simultaneously. ▶Page 17

Other function



COMFORT AIRFLOW







The airflow direction will be in upward mode while COOL operation, in downward mode while in HEAT operation. This function will prevent cold or warm air from directly blowing on your body. ▶Page 15

Contents

■ Read before Operation

Safety Precautions	3
Name of Parts	5
Preparation before Operation	9

■ Operation

 AUTO · DRY · COOL · HEAT · FAN Operation	11
 Adjusting the Airflow Direction and Rate	13
 COMFORT AIRFLOW Operation	15
 POWERFUL Operation	16
 ECONO Operation	17
 OFF TIMER Operation	18
 ON TIMER Operation	19

■ Care

Care and Cleaning	20
-------------------------	----

■ Troubleshooting

Troubleshooting	25
-----------------------	----







Safety Precautions

- Read these safety considerations for operations carefully before installing air conditioning equipment. After completing the installation, make sure that the unit operates properly during the startup operation. Instruct the customer on how to operate and maintain the unit.

Inform customers that they should store this operation manual with the installation manual for future reference.

Meanings of DANGER, WARNING, CAUTION, and NOTE Symbols:





 DANGER	 WARNING	 CAUTION
Indicates an imminently hazardous situation which, if not avoided, will result in death or serious injury.	Indicates a potentially hazardous situation which, if not avoided, could result in death or serious injury.	Indicates a potentially hazardous situation which, if not avoided, may result in minor or moderate injury. It may also be used to alert against unsafe practices.

 Never do.	 Be sure to follow the instructions.
 Be sure to ground the air conditioner.	 Never allow the air conditioner or remote controller to get wet.
 Never touch the air conditioner (including the remote controller) with a wet hand.	





DANGER

- For refrigerant leakage, consult your dealer.
Refrigerant gas is heavier than air and replaces oxygen. A massive leak could lead to oxygen depletion, especially in basements, and an asphyxiation hazard could occur leading to serious injury or death.
- Refrigerant gas may produce a toxic gas if it comes in contact with fire such as from a fan heater, stove or cooking device. Exposure to this gas could cause severe injury or death.
- Any abnormalities in the operation of the air conditioner such as smoke or fire could result in severe injury or death.
Turn off the power and contact your dealer immediately for instructions.
- Do not install the unit in an area where flammable materials are present due to risk of explosion resulting in serious injury or death.
- If equipment utilizing a burner is used in the same room as the air conditioner, there is the danger of oxygen deficiency which could lead to an asphyxiation hazard resulting in serious injury or death.
Be sure to ventilate the room sufficiently to avoid this hazard.
- Safely dispose of the packing materials.
Packing materials, such as nails and other metal or wooden parts, may cause stabs or other injuries. Tear apart and throw away plastic packaging bags so that children will not play with them. Children playing with plastic bags face the danger of death by suffocation.





WARNING

-  It is not good for health to expose your body to the air flow for a long time.
-  Do not put your finger or other objects into the air outlet or inlet as the fan is rotating at high speed and could cause injury. Always keep small children away from the unit during operation.
-  Do not attempt to repair, relocate, modify or reinstall the air conditioner by yourself. Incorrect work or modifications could cause electric shocks, fire or other damage.
For repairs and reinstallation, consult your Daikin dealer for advice and information.
-  If the air conditioner is not cooling (heating) properly, the refrigerant may be leaking, contact your authorized dealer or qualified service repairman.
When making repairs which requires adding refrigerant, consult with your authorized dealer or qualified service repairman.
-  Do not attempt to install the air conditioner by yourself. Improper installation could result in water leakage, electric shocks or fire. For installation, consult your authorized dealer or a qualified technician.

CAUTION

-  The air conditioner must be grounded. Improper grounding may result in electric shocks. Do not connect the grounding wire to a gas pipe, water pipe, lightning rod, or a telephone ground line. Follow all local and state electrical codes.
-  Do not use this unit for cooling precision instruments, food, plants, animals or works of art.
-  Never expose little children, plants or animals directly to the air flow.
-  Do not block air inlets nor outlets. Impaired air flow may result in poor performance or equipment problems.
-  Do not stand, sit, or place objects on the outdoor unit. To avoid injury, do not remove the fan guard.

CAUTION

-  • Do not place anything under the indoor or outdoor unit that must be kept away from moisture, such as electrical or electronic equipment. In certain conditions, moisture in the air may condense and drip.
 - Check the unit stand and fittings for damage annually.
 - Do not touch the air inlet and aluminum fins of outdoor unit. It may cause injury and/or damage the heat transfer surface.
 - This appliance is NOT intended for use by young children or impaired persons without proper supervision.
 - Young children should be supervised to ensure that they DO NOT play with or near the air flow of this appliance.
 - Do not pull at the conduit or hang anything on it. Otherwise it will cause fire or electric shock.
 - Do not touch the heat exchanger fins. Improper handling may result in injury.
 - Do not turn off the power immediately after stopping operation. Always wait at least 5 minutes before turning off the power to avoid water leakage or other problems.
-
-  • To avoid personal injury or equipment damage be sure to stop the operation, turn the breaker off or pull out the supply cord before cleaning or servicing the unit. NOTE: More than one disconnect may be required to shut off all power.
 - Do not connect the air conditioner to a power supply different from the one specified. It may cause improper operation or fire.
 - Depending on the environment, state and local electrical codes, a ground fault circuit interrupter may be required. Improper grounding or lack of a ground fault circuit interrupter may result in electrical shock, injuries, or death.
 - It is recommended to install a ground fault circuit interrupter if one is not already available.
This helps prevent electrical shocks or fire.
 - Arrange the drain hose to ensure smooth drainage. Improper drainage may cause water damage to the building, or its furnishing.
 - Depending on the usage environment, water may leak from the air conditioner. If this happens, contact your Daikin Dealer.
 - The remote controller should be installed in such way that children cannot play with it.
 - Do not place objects in direct proximity of the outdoor unit and do not let leaves and other debris accumulate around the unit. Leaves are a hotbed for small animals which can enter the unit. Once in the unit, such animals can cause malfunctions, smoke or fire when making contact with electrical parts.
-
-  • Do not operate the air conditioner with wet hands.
-
-  • Do not wash the indoor unit with excessive water, only use a slightly wet cloth.
 - Do not place things such as vessels containing water or anything else on top of the unit. Water may penetrate into the unit and degrade electrical insulations, resulting in an electric shock.

Installation site.

- Operate the air conditioner in a sufficiently ventilated area and not surrounded by obstacles. Do not use the air conditioner in the following places.
 - a. Places with a mist of mineral oil, such as cutting oil.
 - b. Locations such as coastal areas where there is a lot of salt in the air.
 - c. Locations such as hot springs where there is a lot of sulfur in the air.
 - d. Locations such as factories where the power voltage varies a lot.
 - e. In cars, boats, and other vehicles.
 - f. Locations such as kitchens where oil may splatter or where there is steam in the air.
 - g. Locations where equipment produces electromagnetic waves.
 - h. Places with an acid or alkaline mist.
 - i. Places where fallen leaves can accumulate or where weeds can grow.

Consider the nuisance of noise to your neighbors.

- Pay Attention to Operating Sound. Be sure to use the following places:
 - a. Places that can sufficiently withstand the weight of the air conditioner yet can suppress the operating sound and vibration of the air conditioner.
 - b. Places where warm air from the air outlet of the outside unit or the operating sound of the outside unit does not annoy neighbors. Make sure that there are no obstacles close to the outside unit. Obstacles close to the outside unit may drop the performance of the outside unit or increase the operating sound of the outside unit.
Consult your dealer if the air conditioner in operation generates unusual noise.

Electrical work.

- For power supply, be sure to use a separate power circuit dedicated to the air conditioner.

System relocation.

- Relocating the air conditioner requires specialized knowledge and skills. Please consult the dealer if relocation is necessary for moving or remodeling.

Name of Parts

Indoor Unit

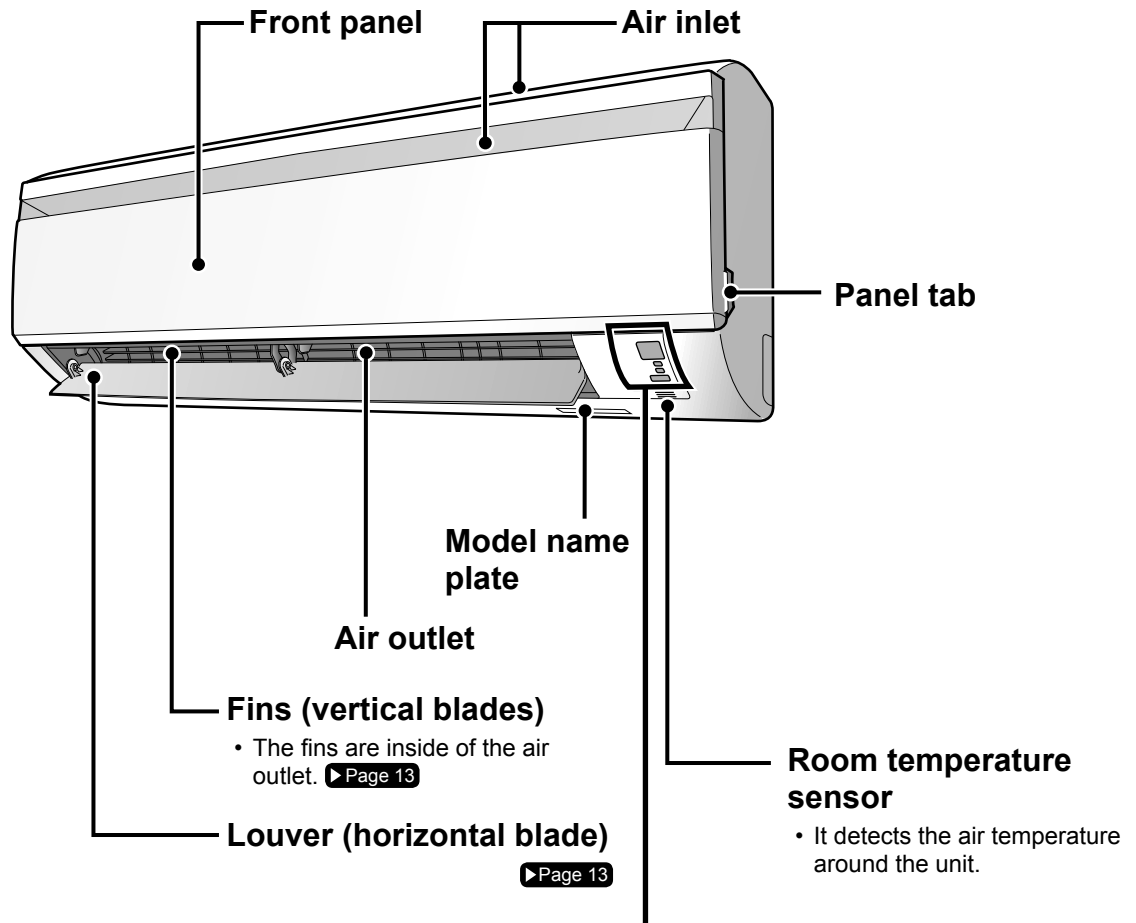

Display

Signal receiver

- It receives signals from the remote controller.
- When the unit receives a signal, you will hear a beep sound.

Case	Sound type
Operation start	beep-beep
Setting changed	beep
Operation stop	long beep

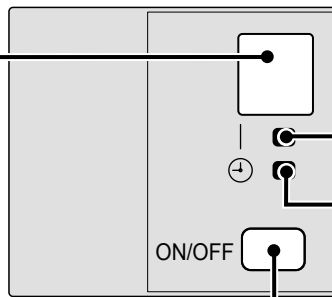

Indoor unit ON/OFF switch

- Press this switch once to start operation. Press once again to stop it.
- The operation mode refer to the following table.

Model	Mode	Temperature setting	Airflow rate
COOLING ONLY	COOL	72°F (22°C)	AUTO
HEAT PUMP	AUTO	77°F (25°C)	AUTO

- This switch is useful when the remote controller is missing.

■ Open the front panel

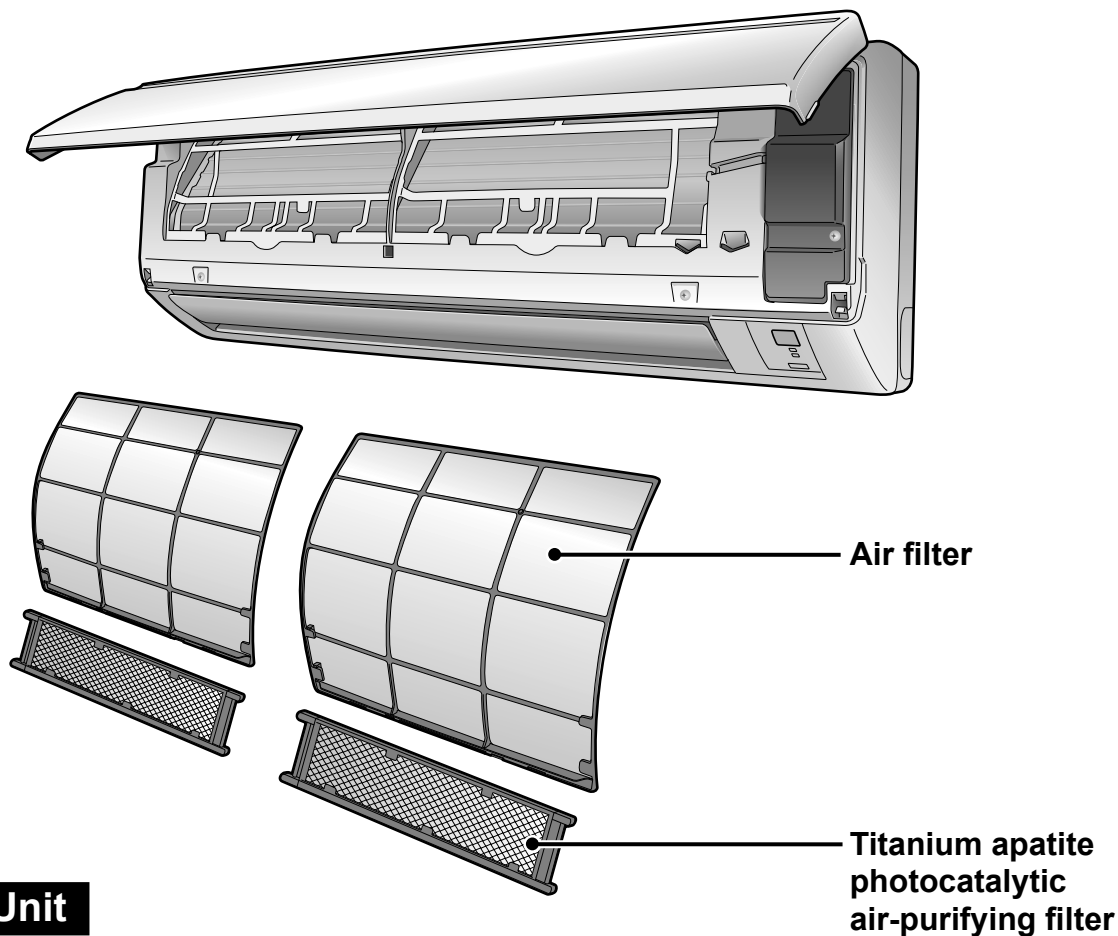

Outdoor Unit

• Appearance of the outdoor unit may differ from some models.

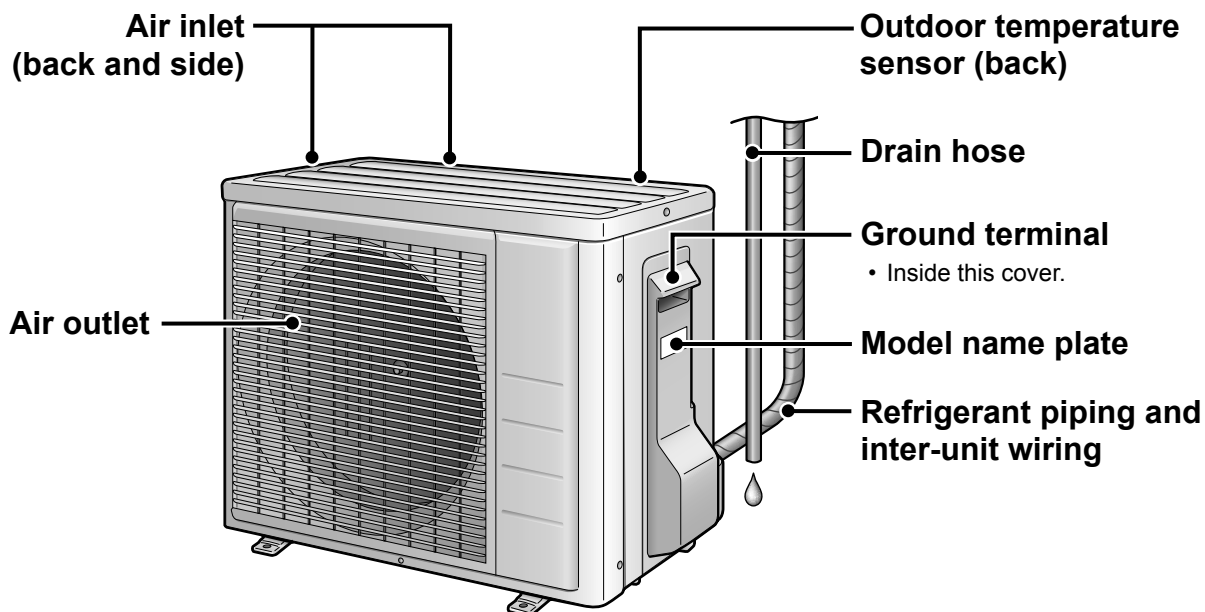

Name of Parts

Remote Controller

Signal transmitter

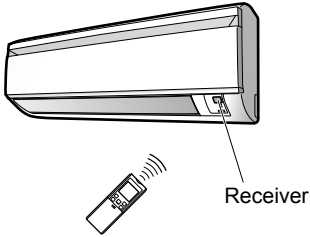

- To use the remote controller, aim the transmitter at the indoor unit. If there is anything to block signals between the unit and the remote controller, such as a curtain, the unit will not operate.
- Do not drop the remote controller. Do not get it wet.
- The maximum distance for communication is approximately 23ft (7m).

FAN setting button

- Selects the airflow rate setting.

▶ Page 14

POWERFUL button

- POWERFUL operation.

▶ Page 16

Display (LCD)

- Displays the current settings. (In this illustration, each section is shown with all its displays for the purpose of explanation.)

TEMPERATURE adjustment buttons

- Changes the temperature setting.

▶ Page 12

ON/OFF button

- Press this button once to start operation.

Press once again to stop it. ▶ Page 11

Front cover

- Open the front cover.

▶ Page 8

HEAT PUMP model	ARC452A12
COOLING ONLY model	ARC452A14

■ Open the front cover

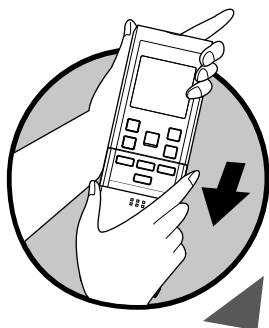

COMFORT button
 • COMFORT AIRFLOW operation. ▶Page 15

OFF TIMER button
 ▶Page 18

TIMER CANCEL button
 • Cancels the timer setting.
 ▶Page 18,19

MODE selector button
 • Selects the operation mode.
 (AUTO/DRY/COOL/HEAT/FAN) ▶Page 11

ECONO button
 • ECONO operation. ▶Page 17

SWING button
 • Adjusting the airflow direction.
 ▶Page 13

ON TIMER button
 ▶Page 19

CLOCK button ▶Page 10

SELECT button
 • Changes the ON/OFF TIMER settings.
 ▶Page 18,19

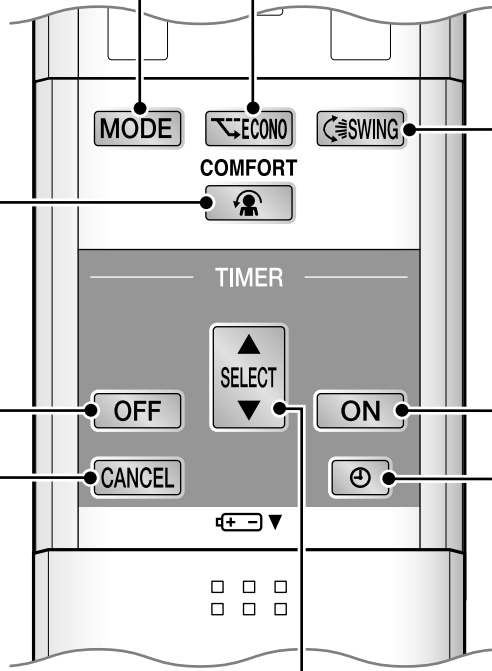

Preparation before Operation

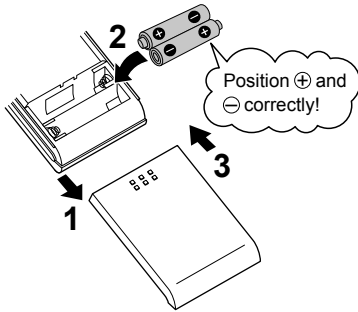

■ To set the batteries

1. Slide the front cover to take it off.
2. Set two dry batteries AAA.LR03 (alkaline).
3. Set the front cover as before.

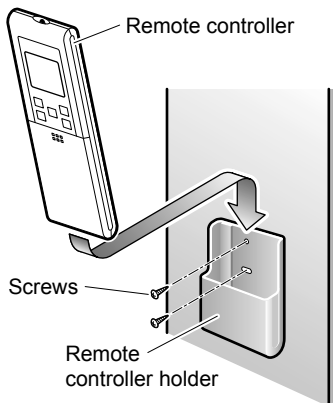

■ To fix the remote controller holder on the wall



1. Choose a place from where the signals reach the unit.
2. Fix the holder to a wall, a pillar, etc. with the screws supplied with the holder.
3. Place the remote controller in the remote controller holder.

■ Celsius/Fahrenheit display switch

- The Celsius or Fahrenheit display is selectable with the following buttons.

Press  and  simultaneously for 5 seconds.

- The temperature will be displayed in Fahrenheit if it is presently displayed in Celsius, and vice versa.

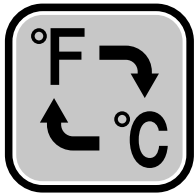

NOTE

■ Notes on batteries

- When replacing the batteries, use batteries of the same type, and replace both batteries at the same time.
- When the system is not used for a long time, take the batteries out.
- The batteries will last for approximately 1 year. If the remote controller display begins to fade and the degradation of reception performance occurs within a year, however, replace both batteries with new, size AAA.LR03 (alkaline).
- The attached batteries are provided for the initial use of the system.
The usable period of the batteries may be short depending on the manufactured date of the air conditioner.

■ Notes on remote controller

- Never expose the remote controller to direct sunlight.
- Dust on the signal transmitter or receiver will reduce the sensitivity. Wipe off dust with a soft cloth.
- Signal communication may be disabled if an electronic-starter-type fluorescent lamp (such as inverter-type lamps) is in the room. Consult the shop if that is the case.
- If the remote controller signals happen to operate another appliance, move that appliance somewhere else, or consult the service shop.

■ Celsius/Fahrenheit display change function of remote controller

- The set temperature may increase when the display is changed to Celsius from Fahrenheit, because a fraction of 0.5°C is rounded up.
- Example: A set temperature of 65°F (equivalent to 18.5°C) will be converted into 19°C.
When the display is changed to Fahrenheit again, the set temperature will be converted into 66°F (equivalent to 19°C) instead of the original set temperature (65°F) but a set temperature of 66°F (equivalent to 19°C) will be converted into 19°C with no temperature change.
- A reception sound will go off for the transmission of set temperature to the indoor unit at the time of setting the Celsius/Fahrenheit display change function.

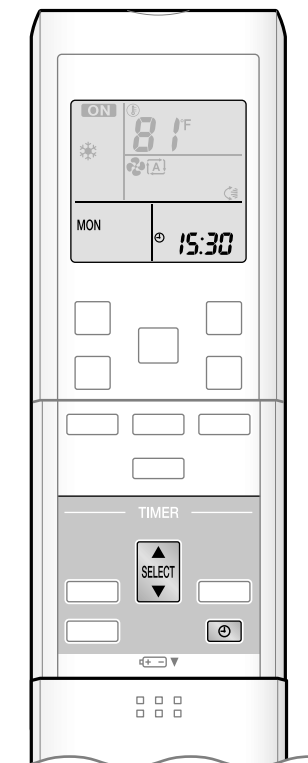

■ Turn the breaker on

- Turning on the breaker opens once and closes the louver. (This is a normal procedure.)

■ To set the clock

1. Press .

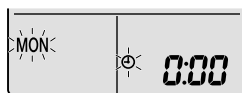

- "0:00" is displayed.
- "MON" and "☉" blinks.

2. Press to set the current day of the week.

3. Press .



- "☉" blinks.

4. Press to set the clock to the present time.

- Holding down ▲ or ▼ rapidly increases or decreases the time display.

5. Press .

- Always point the remote controller at the indoor unit when pressing the buttons when setting the indoor unit's internal clock.



- "☉" blinks.



AUTO · DRY · COOL · HEAT · FAN Operation

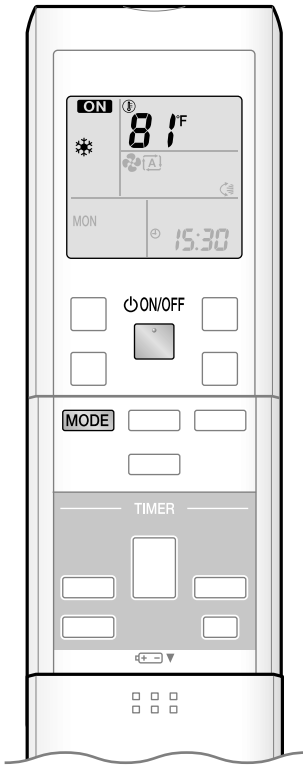

The air conditioner operates with the operation mode of your choice.
From the next time on, the air conditioner will operate with the same operation mode.

To start operation

1. Press **MODE** and select a operation mode.

- Each pressing of the button advances the mode setting in sequence.

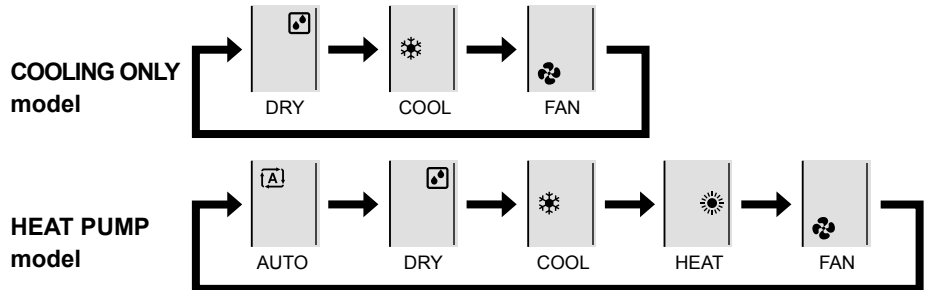

2. Press .

- “**ON**” is displayed on the LCD.
- The OPERATION lamp lights up.

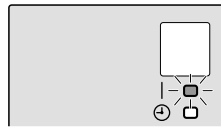

Display

To stop operation

Press  again.



- “**ON**” is no longer displayed on the LCD.
- The OPERATION lamp goes off.

NOTE

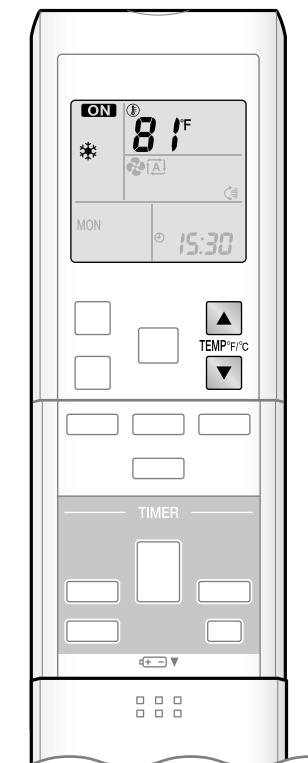
MODE	Notes on each operation mode
HEAT	<ul style="list-style-type: none"> • Since this air conditioner heats the room by taking heat from outdoor air to indoors, the heating capacity becomes smaller in lower outdoor temperatures. If the heating effect is insufficient, it is recommended to use another heating appliance in combination with the air conditioner. • The heat pump system heats the room by circulating hot air around all parts of the room. After the start of HEAT operation, it takes some time before the room gets warmer. • In HEAT operation, frost may occur on the outdoor unit and lower the heating capacity. In that case, the system switches into defrosting operation to take away the frost. • During defrosting operation, hot air does not flow out of indoor unit.
COOL	<ul style="list-style-type: none"> • This air conditioner cools the room by blowing the hot air in the room outside, so if the outside temperature is high, the performance of the air conditioner drops.
DRY	<ul style="list-style-type: none"> • The computer chip works to rid the room of humidity while maintaining the temperature as much as possible. It automatically controls temperature and airflow rate, so manual adjustment of these functions is unavailable.
AUTO	<ul style="list-style-type: none"> • In AUTO operation, the system selects a temperature setting and an appropriate operation mode (COOL or HEAT) based on the room temperature at the start of the operation. • The system automatically reselects setting at a regular interval to bring the room temperature to user-setting level.
FAN	<ul style="list-style-type: none"> • This mode is valid for fan only.



■ To change the temperature setting

Press  or  .

- The displayed items on the LCD will change whenever either one of the buttons is pressed.

COOL operation	HEAT operation	AUTO operation	DRY or FAN operation
64-90°F (18-32°C)	50-86°F (10-30°C)	64-86°F (18-30°C)	The temperature setting is not variable.
Press ▲ to raise the temperature and press ▼ to lower the temperature.			

■ Operating conditions

■ Recommended temperature setting

- For cooling: 78-82°F (26-28°C)
- For heating: 68-75°F (20-24°C)

■ Tips for saving energy

- Be careful not to cool (heat) the room too much.
Keeping the temperature setting at a moderate level helps save energy.
- Cover windows with a blind or a curtain.
Blocking sunlight and air from outdoors increases the cooling (heating) effect.
- Clogged air filters cause inefficient operation and waste energy. Clean them once in about every 2 weeks.

■ Notes on the operating conditions

- The air conditioner always consumes 50-120btu/h (15-35W) of electricity even while it is not operating.
The outdoor unit consumes 3.4-34btu/h (1-10W) to have its electric components work even while it is not operating.
During standby electricity saving mode : about 3.4btu/h (1W)
The outdoor unit consumes about 120btu/h (35W) of power at the time of compressor preheating.
- If you are not going to use the air conditioner for a long period, for example in spring or autumn, turn the breaker off.
- Use the air conditioner in the following conditions.

MODE	Operating conditions	If operation is continued out of this range
COOL	Outdoor temperature : 50-115°F (10-46°C) Indoor temperature : 64-90°F (18-32°C) Indoor humidity : 80% max.	<ul style="list-style-type: none"> • A safety device may work to stop the operation. • Condensation may occur on the indoor unit and drip.
HEAT	Outdoor temperature : 5-75°F (-15-24°C) Indoor temperature : 50-86°F (10-30°C)	<ul style="list-style-type: none"> • A safety device may work to stop the operation.
DRY	Outdoor temperature : 50-115°F (10-46°C) Indoor temperature : 64-90°F (18-32°C) Indoor humidity : 80% max.	<ul style="list-style-type: none"> • A safety device may work to stop the operation. • Condensation may occur on the indoor unit and drip.

- Operation outside this humidity or temperature range may cause a safety device to disable the system.



Adjusting the Airflow Direction and Rate

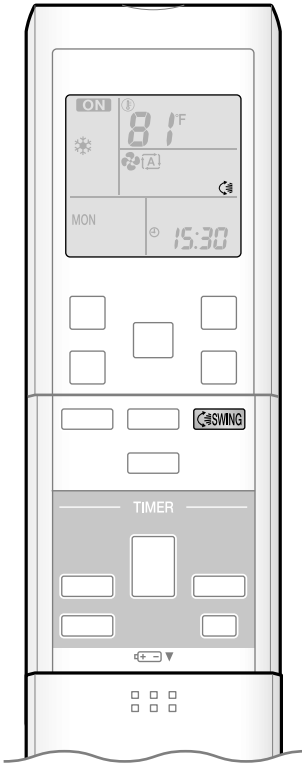

You can adjust the airflow direction to increase your comfort.

■ To start auto swing

Upper and lower airflow direction

Press  SWING.

- “” is displayed on the LCD.
- The louver (horizontal blade) will begin to swing.

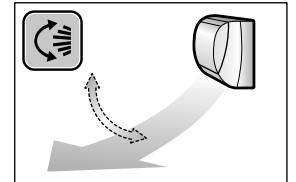

■ To set the louver at desired position

- This function is effective while louver is in auto swing mode.

Press  SWING when the louver has reached the desired position.

- The louver will stop moving.
- “” is no longer displayed on the LCD.

■ To adjust the fins (vertical blades)

Hold the knob and move the fins.
(You will find a knob on the left-side and the right-side blades.)

- When the unit is installed in the corner of a room, the direction of the fins should be facing away from the wall. If they face the wall, the wall will block off the wind, causing the cooling (or heating) efficiency to drop.

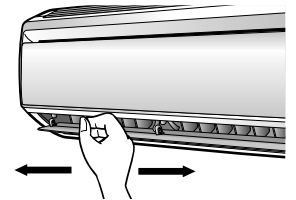

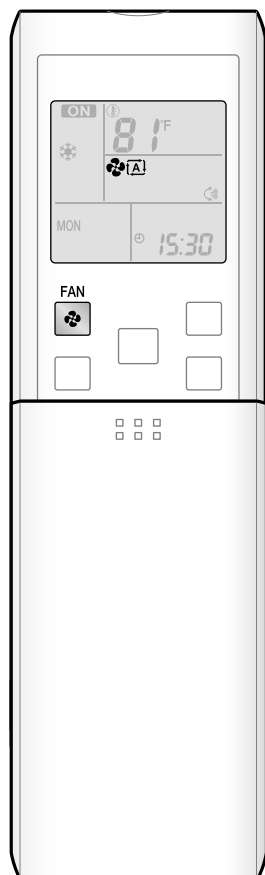



■ To adjust the airflow rate setting

Press .

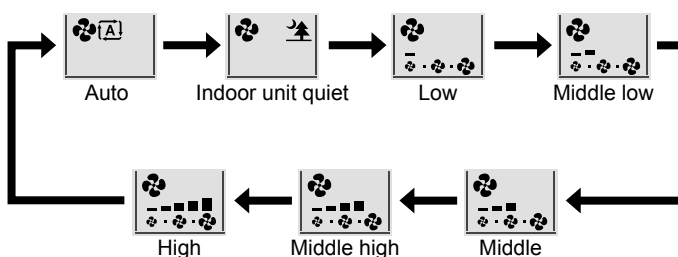
- Each pressing of  advances the airflow rate setting in sequence.



- When the airflow is set to “”, indoor unit quiet operation will start and the noise from the unit will become quieter.
- In indoor unit quiet operation, the airflow rate is set to a weak level.
- In DRY operation, the airflow rate setting is not variable.

NOTE

■ Notes on the angles of the louver

- The louver swinging range depends on the operation. (See the figure.)

COOL and DRY operation

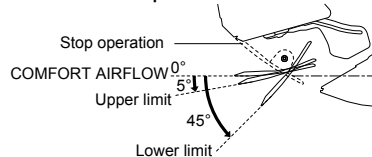

HEAT operation

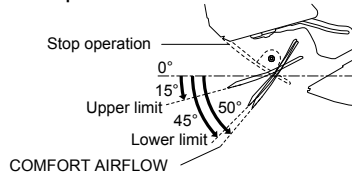

FAN operation

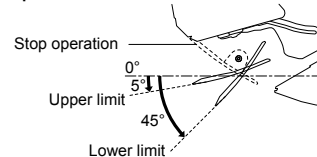

- If the air conditioner is HEAT or DRY operation with the louver kept stopped in the downward direction, the louver will automatically start operating in approximately an hour in order to prevent dew condensation.

■ Note on airflow rate setting

- At smaller airflow rates, the cooling (heating) effect is also smaller.

CAUTION

- Always use a remote controller to adjust the angles of the louver. If you attempt to move it forcibly with hand when it is swinging, the mechanism may be broken.
- Be careful when adjusting the fins. Inside the air outlet, a fan is rotating at a high speed.



COMFORT AIRFLOW Operation

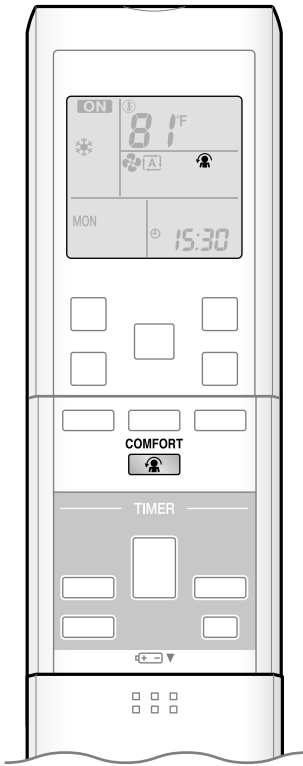

The flow of air will be in the upward direction while in COOL operation and in the downward direction while in HEAT operation, which will provide a comfortable wind that will not come in direct contact with people.

■ To start COMFORT AIRFLOW operation

Press .

- “” is displayed on the LCD.
- Airflow rate is set to auto.
<COOL/DRY> The louver will go up.
<HEAT> The louver will go down.

■ To cancel COMFORT AIRFLOW operation

Press  again.

- The louver will return to the memory position from before COMFORT AIRFLOW operation.
- “” is no longer displayed on the LCD.

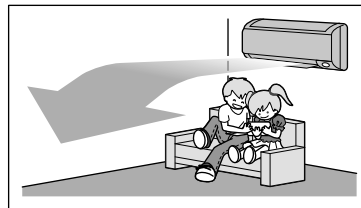

COOL operation

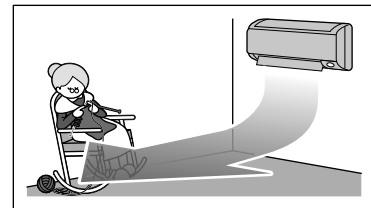

HEAT operation

NOTE

■ Notes on COMFORT AIRFLOW operation

- The louver position will change, preventing air from blowing directly on the occupants of the room.
- POWERFUL operation and COMFORT AIRFLOW operation cannot be used at the same time.
Priority is given to the function of whichever button is pressed last.
- The airflow rate will be set to auto. If the upper and lower airflow direction is selected, the COMFORT AIRFLOW operation will be canceled.



POWERFUL Operation

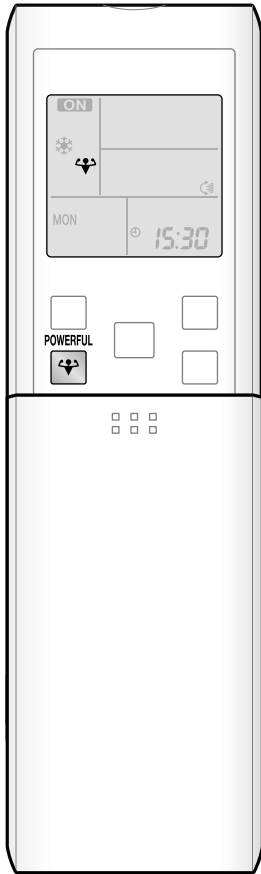

POWERFUL operation quickly maximizes the cooling (heating) effect in any operation mode. You can get the maximum capacity.

■ To start POWERFUL operation

Press  during operation.

- POWERFUL operation ends in 20 minutes. Then the system automatically operates again with the previous settings which were used before POWERFUL operation.
- “” is displayed on the LCD.

■ To cancel POWERFUL operation

Press  again.

- “” is no longer displayed on the LCD.

[Example]

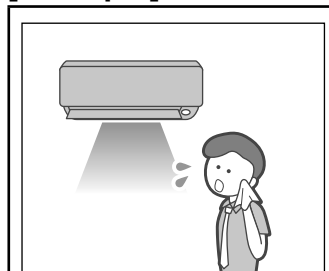

■ Normal operation

- When you want to get the cooling effect quickly, start the POWERFUL operation.

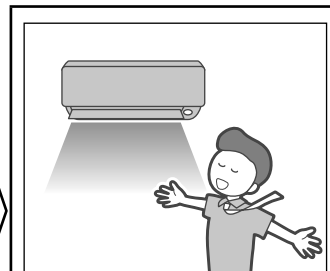

■ POWERFUL operation

- POWERFUL operation will work for 20 minutes.

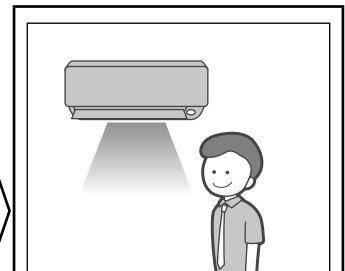

■ Back to normal operation

NOTE

■ Notes on POWERFUL operation

- When using POWERFUL operation, there are some functions which are not available.
- POWERFUL operation cannot be used together with ECONO and COMFORT AIRFLOW operation. Priority is given to the function of whichever button is pressed last.
- POWERFUL operation will not increase the capacity of the air conditioner if the air conditioner is already in operation with its maximum capacity demonstrated.
- **In COOL and HEAT operation**
To maximize the cooling (heating) effect, the capacity of outdoor unit must be increased and the airflow rate be fixed to the maximum setting. The temperature and airflow settings are not variable.
- **In DRY operation**
The temperature setting is lowered by 4.5°F (2.5°C) and the airflow rate is slightly increased.
- **In FAN operation**
The airflow rate is fixed to the maximum setting.
- **In AUTO operation**
To maximize the cooling (heating) effect, the capacity of outdoor unit must be increased and the airflow rate be fixed to the maximum setting.



ECONO Operation

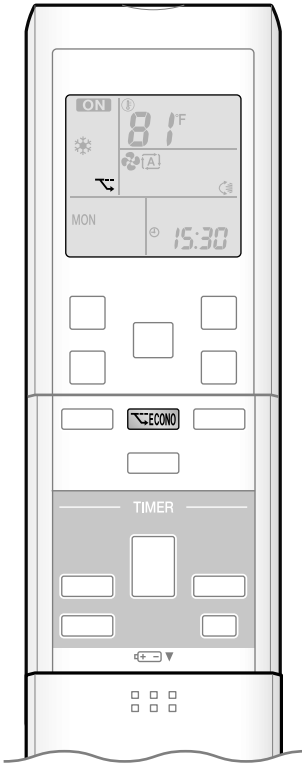

ECONO operation is a function which enables efficient operation by limiting the maximum power consumption value.

This function is useful for cases in which attention should be paid to ensure a circuit breaker will not trip when the product runs alongside other appliances.

■ To start ECONO operation

Press during operation.

- “” is displayed on the LCD.

■ To cancel ECONO operation

Press again.

- “” is no longer displayed on the LCD.

[Example]

Normal operation



- In case the air conditioner and other appliances which require high power consumption are used at same time, a circuit breaker may trip if the air conditioner operate with its maximum capacity.

ECONO operation

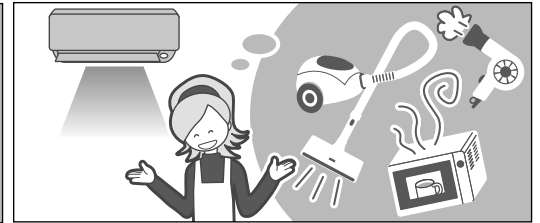

- The maximum power consumption of the air conditioner is limited by using ECONO operation. The circuit breaker is unlikely to trip even if the air conditioner and other appliances are used at same time.

Running current and power consumption

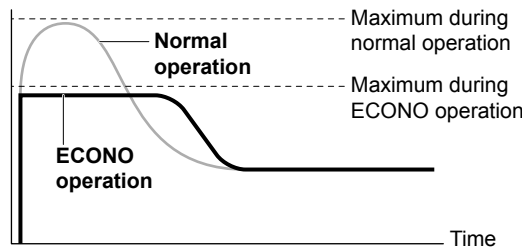

From start up until set temperature is reached

- This diagram is a representation for illustrative purposes only.

The maximum running current and power consumption of the air conditioner in ECONO operation vary with the connecting outdoor unit.

NOTE

■ Notes on ECONO operation

- ECONO operation is a function which enables efficient operation by limiting the power consumption of the outdoor unit (operating frequency).
- ECONO operation functions in AUTO, COOL, DRY, and HEAT operation.
- POWERFUL and ECONO operation cannot be used at the same time. Priority is given to the function of whichever button is pressed last.
- If the level of power consumption is already low, ECONO operation will not drop the power consumption.



OFF TIMER Operation

Timer functions are useful for automatically switching the air conditioner on or off at night or in the morning. You can also use OFF TIMER and ON TIMER in combination.

■ To use OFF TIMER operation

- Check that the clock is correct.
If not, set the clock to the present time. ▶Page 10

1. Press OFF.

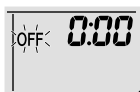

“0:00” is displayed on the LCD.
“OFF” blinks.

- “⊕” is no longer displayed on the LCD.

2. Press SELECT until the time setting reaches the point you like.



- Each pressing of either button increases or decreases the time setting by 10 minutes. Holding down either button changes the time setting rapidly.

3. Press OFF again.

- “OFF” and setting time are displayed on the LCD.
- The TIMER lamp lights up.

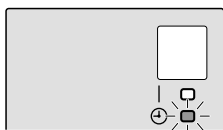

Display

■ To cancel OFF TIMER operation

Press CANCEL.

- “OFF” and setting time are no longer displayed on the LCD.
- “⊕” and day of the week are displayed on the LCD.
- The TIMER lamp goes off.

NOTE

■ Notes on TIMER operation

- When TIMER is set, the present time is not displayed.
- Once you set ON/OFF TIMER, the time setting is kept in the memory. The memory is canceled when remote controller batteries are replaced.
- When operating the unit via the ON/OFF TIMER, the actual length of operation may vary from the time entered by the user. (Maximum approximately 10 minutes)

■ NIGHT SET mode

- When the OFF TIMER is set, the air conditioner automatically adjusts the temperature setting (0.9°F (0.5°C) up in COOL, 3.6°F (2.0°C) down in HEAT) to prevent excessive cooling (heating) for your pleasant sleep.



ON TIMER Operation

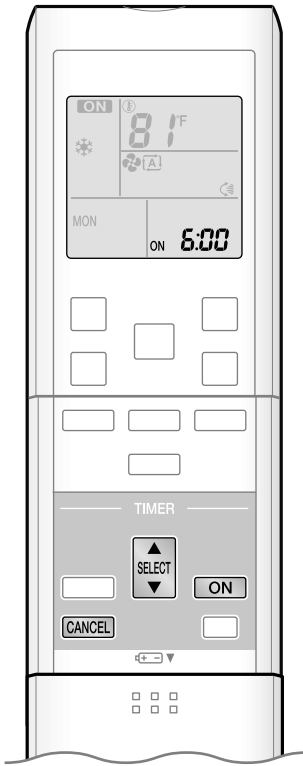

■ To use ON TIMER operation

- Check that the clock is correct.
If not, set the clock to the present time. ▶Page 10

1. Press **ON**.

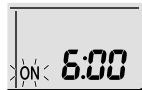

“6:00” is displayed on the LCD.
“ON” blinks.

- “⊕” is no longer displayed on the LCD.

2. Press **SELECT** until the time setting reaches the point you like.

- Each pressing of either button increases or decreases the time setting by 10 minutes.
Holding down either button changes the setting rapidly.

3. Press **ON** again.

- “ON” and setting time are displayed on the LCD.
- The TIMER lamp lights up.

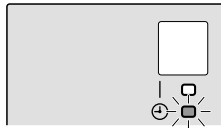

Display

■ To cancel ON TIMER operation

Press **CANCEL**.

- “ON” and setting time are no longer displayed on the LCD.
- “⊕” and day of the week are displayed on the LCD.
- The TIMER lamp goes off.

■ To combine ON TIMER and OFF TIMER

- A sample setting for combining the 2 timers is shown below.

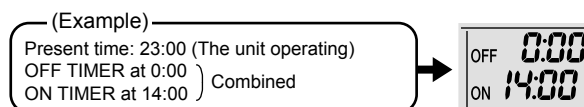

NOTE

■ In the following cases, set the timer again.

- After a breaker has turned off.
- After a power failure.
- After replacing batteries in the remote controller.

Care and Cleaning

■ Quick reference

How to open / close the front panel

- Hold the front panel by the panel tabs on the both sides and open it.
- Press the front panel at both sides and the center to close it.

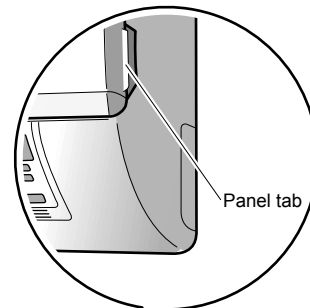

Cleaning parts

Front panel

- Wipe it with a soft cloth when dirty.

Refer to ▶Page 21

Air filter

- Vacuum dust or wash filter.

Once every 2 weeks

Refer to ▶Page 22

Titanium apatite photocatalytic air-purifying filter

- Vacuum dust or replace the filter.

[Cleaning]

Once every 6 months

Refer to ▶Page 23

[Replacement]

Once every 3 years

Refer to ▶Page 23

Indoor unit, outdoor unit and remote controller

- Wipe them with a soft cloth when dirty.

Notes on cleaning

■ For cleaning, do not use the materials as follows.

- Hot water above 104°F (40°C).
- Benzine, gasoline, thinner, other volatile oils.
- Polishing compound.
- Scrubbing brushes, other hard stuff.



⚠ CAUTION

- Before cleaning, be sure to stop the operation and turn the breaker off.
- Do not touch the metal parts of the indoor unit. If you touch those parts, this may cause an injury.

Care and Cleaning

■ Front panel

1. Remove the front panel.

- Open the front panel.
- Slide the front panel to either the left or right and pulling it toward you. This will disconnect the rotation dowel on one side.

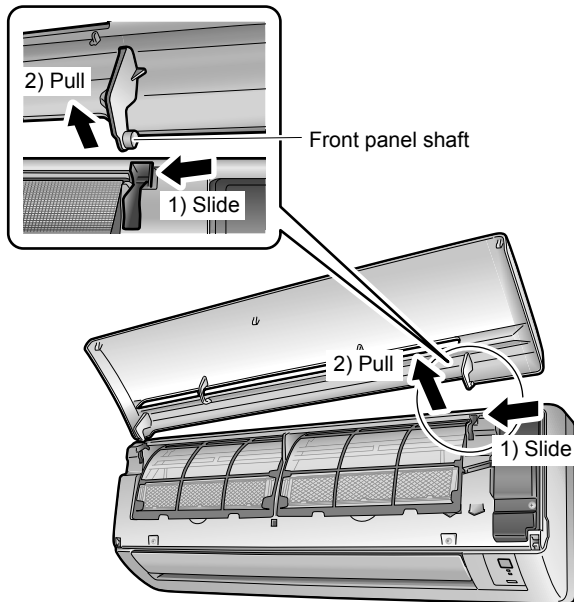

- Disconnect the front panel shaft on the other side in the same manner.

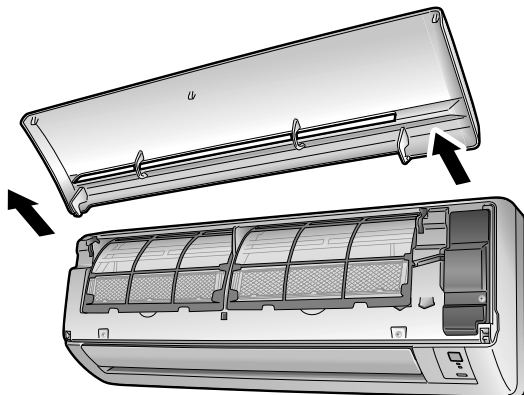

2. Clean the front panel.

- Wipe it with a soft cloth soaked in water.
- Only neutral detergent may be used.
- If you wash the panel with water, wipe it with a dry soft cloth, and allow to dry in the shade.

3. Attach the front panel.

- Align the front panel shaft on the left and right of the front panel with the slots, then push them all the way in.

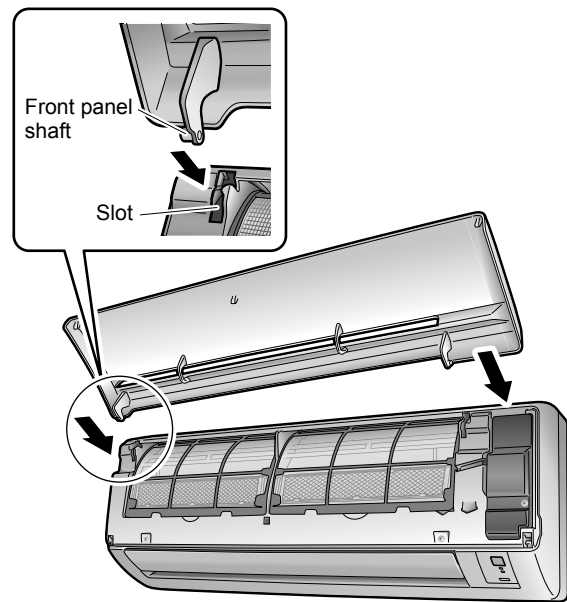

- Close the front panel slowly. (Press the panel at both sides and the center.)

⚠ CAUTION

- When removing or attaching the front panel, use a robust and stable stool and watch your steps carefully.
- When removing or attaching the front panel, support the panel securely with hand to prevent it from falling.
- After cleaning, make sure that the front panel is securely fixed.

■ Air filter

1. Pull out the air filters.

- Open the front panel.
- Push the filter tab at the center of each air filter slightly upward, then pull it down.

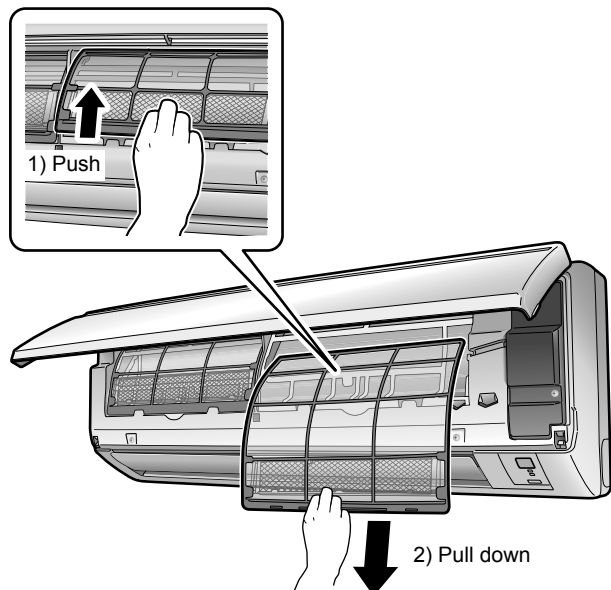

2. Wash the air filters with water or clean them with vacuum cleaner.

- It is recommended to clean the air filters every 2 weeks.

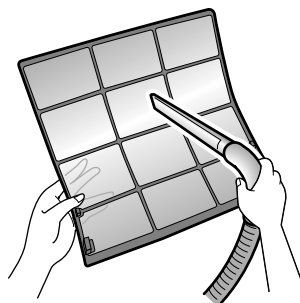

If the dust does not come off easily

- Wash the air filters with neutral detergent thinned with lukewarm water, then allow to dry in the shade.
- Be sure to remove the titanium apatite photocatalytic air-purifying filter. Refer to titanium apatite photocatalytic air-purifying filter on the next page.

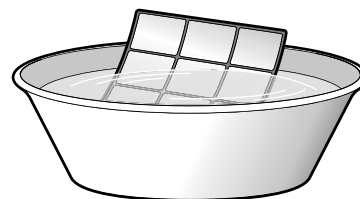

3. Set the filters as they were and close the front panel.

- Press the front panel at both sides and the center.

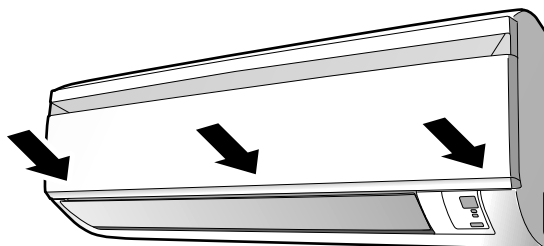

⚠ CAUTION

- Do not touch the aluminum fins by bare hand at the time of dismantling or mounting the filter.

Care and Cleaning

■ Titanium apatite photocatalytic air-purifying filter

1. Take off the titanium apatite photocatalytic air-purifying filter.

- Open the front panel and pull out the air filters.
- Hold the recessed parts of the frame and unhook the 4 claws.

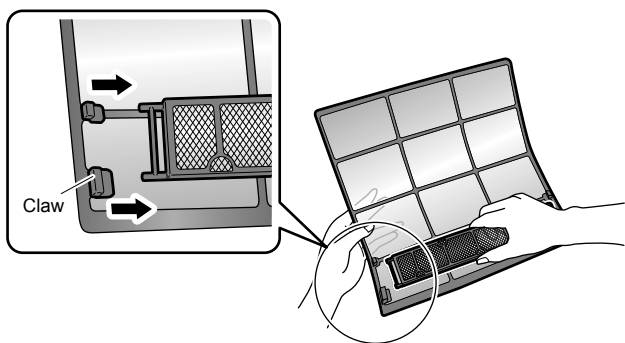

2. Clean or replace the titanium apatite photocatalytic air-purifying filter.

[Maintenance]

2-1 Vacuum dust, and soak in lukewarm water or water for about 10 to 15 minutes if dirt is heavy.

- Do not remove the filter from frame when washing with water.

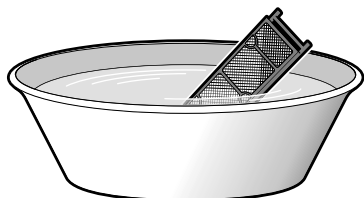

2-2 After washing, shake off remaining water and dry in the shade.

- Since the material is made out of polyester, do not wring out the filter when removing water from it.

[Replacement]

Remove the tabs on the filter frame and replace with a new filter.

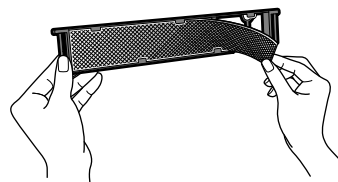

- Do not throw away the filter frame. Reuse the filter frame when replacing the titanium apatite photocatalytic air-purifying filter.
- Dispose of the old filter as non-flammable waste.

3. Set the filters as they were and close the front panel.

- Press the front panel at both sides and the center.

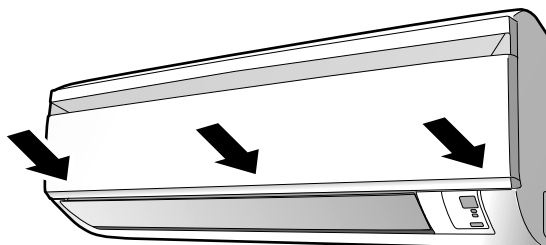

NOTE

- Operation with dirty filters:
 - cannot deodorize the air,
 - cannot clean the air,
 - results in poor heating or cooling,
 - may cause odor.
- Dispose of old filters as non-flammable waste.
- To order titanium apatite photocatalytic air-purifying filter contact to the service shop there you purchased the air conditioner.



Item	Titanium apatite photocatalytic air-purifying filter (without frame) 1 set
Part No.	KAF970A46

■ Check the units

- Check that the base, stand and other fittings of the outdoor unit are not decayed or corroded.
 - Check that nothing blocks the air inlets and the outlets of the indoor unit and the outdoor unit.
 - Check that the drain comes smoothly out of the drain hose during COOL or DRY operation.
 - If no drain water is seen, water may be leaking from the indoor unit. Stop operation and consult the service shop if this is the case.
-

■ Before a long idle period

1. Operate the FAN only for several hours on a nice day to dry out the inside.

- Press **MODE** and select “” operation.
- Press  and start operation.

2. After operation stops, turn off the breaker for the room air conditioner.

3. Clean the air filters and set them again.

4. Take out batteries from the remote controller.

■ We recommend periodic maintenance

- In certain operating conditions, the inside of the air conditioner may get foul after several seasons of use, resulting in poor performance. It is recommended to have periodic maintenance by a specialist aside from regular cleaning by the user.
- For specialist maintenance, contact the service shop where you purchased the air conditioner.
- The maintenance cost must be born by the user.

Troubleshooting

■ These incidents are not malfunctions.

- The following incidents do not indicate a malfunctioning air conditioner and have explanations. The air conditioner can continue to operate.

Indoor unit

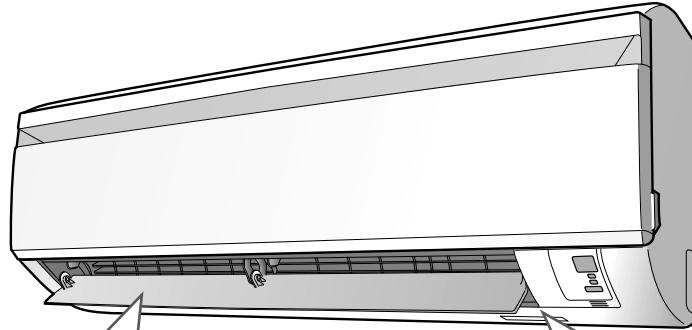

The louver does not immediately swing. The louver moves soon after startup.

- The air conditioner is adjusting the louver position. The louver will start moving soon.

The HEAT operation stops suddenly and a flowing sound is heard.

- The system is taking away the frost on the outdoor unit. You should wait for about 4 to 12 minutes.

Operation does not start soon.

- When “ON/OFF” button was pressed soon after operation was stopped.
- When the mode was reselected.
 - This is to protect the air conditioner. You should wait for about 3 minutes.

Possible sounds.

■ Flowing water

- Generated because the refrigerant in the air conditioner is flowing.
- This is a pumping sound of the water in the air conditioner and heard when the water is pumped out from the air conditioner in cooling or drying operation.
- The refrigerant flows in the air conditioner even if the air conditioner is not working when the indoor units in other rooms are in operation.

■ Blowing

- Generated when the flow of the refrigerant in the air conditioner is switched over.

■ Pinging

- Generated when the size of the air conditioner slightly expands or shrinks as a result of temperature changes.

Outdoor unit

The outdoor unit emits water or steam.

- In HEAT operation
 - The frost on the outdoor unit melts into water or steam when the air conditioner is in defrost operation.
- In COOL or DRY operation
 - Moisture in the air condenses into water on the cool surface of outdoor unit piping and drips.

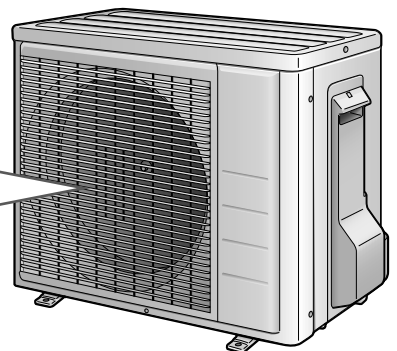

- Troubleshooting measures are classified into the following two types on a remedial basis. Take an appropriate measure according to the symptom.



Not malfunction

- The following conditions do not indicate a problem with the system.



Check

- Please check again before calling a repair person.

The air conditioner does not operate. (OPERATION lamp is off.)

- Is a breaker off or a fuse blown?
- Is there a power failure?
- Are batteries set in the remote controller?
- Is the timer setting correct?



Operation stopped suddenly. (OPERATION lamp flashes.)

- Are the air filters clean?
- Is there anything to block the air inlet or the outlet of the indoor and the outdoor units?
- Clean the air filters or take all obstacles away and turn the breaker off. Then turn it on again and try operating the air conditioner with the remote controller. If the lamp still flashes, call the service shop where you purchased the air conditioner.



Hot air does not flow out soon after the start of HEAT operation.

- The air conditioner is warming up. You should wait for 1 to 4 minutes. (The system is designed to start discharging air only after it has reached a certain temperature.)



Mist comes out of the indoor unit.

- This happens when the air in the room is cooled into mist by the cold airflow during COOL operation.
- This is because the air in the room is cooled by the heat exchanger and becomes mist during defrost operation.



Operation stopped suddenly. (OPERATION lamp is on.)

- For system protection, the air conditioner may stop operating on a sudden large voltage fluctuation. It automatically resumes operation in about 3 minutes.



Troubleshooting

Cooling (Heating) effect is poor.

- Are the air filters clean?
- Is there anything to block the air inlet or the outlet of the indoor and the outdoor units?
- Is the temperature setting appropriate?
- Are the windows and doors closed?
- Are the airflow rate and the airflow direction set appropriately?



The outdoor fan rotates while the air conditioner is not in operation.

■ After operation is stopped

- The outdoor fan continues rotating for another 60 seconds for system protection.

■ While the air conditioner is not in operation

- When the outdoor temperature is very high, the outdoor fan starts rotating for system protection.



Remote controller does not work properly.

■ No remote controller signals are displayed.

■ Remote controller sensitivity is low.

■ Display is low in contrast or blacked out.

■ Display runs out of control.

- The batteries are dying and the remote controller is malfunctioning. Replace all the batteries with new, size AAA.LR03 (alkaline). For details, refer to set the batteries of this manual. ▶Page 9



An abnormal functioning happens during operation.

- The air conditioner may malfunction with lightning or radio waves. Turn the breaker off, turn it on again and try operating the air conditioner with the remote controller.



The indoor unit gives out odor.

- This happens when smells of the room, furniture, or cigarettes are absorbed into the unit and discharged with the airflow. If this happens, have the indoor unit washed by a technician from the service shop where you purchased the air conditioner.



■ Call the service shop immediately

WARNING

- **When an abnormality (such as a burning smell) occurs, stop operation and turn the breaker off.**
 - Continued operation in an abnormal condition may result in malfunctioning, electric shocks or fire.
 - Consult the service shop where you purchased the air conditioner.
- **Do not attempt to repair or modify the air conditioner by yourself.**
 - Incorrect work may result in electric shocks or fire.
 - Consult the service shop where you purchased the air conditioner.

If one of the following symptoms occurs, call the service shop immediately.

- The power cord is abnormally hot or damaged.
- An abnormal sound is heard during operation.
- The safety breaker, a fuse, or the ground leakage breaker cuts off the operation frequently.
- A switch or a button often fails to work properly.
- There is a burning smell.
- Water leaks from the indoor unit.

Turn the breaker off and call the service shop.



■ After a power failure

- The air conditioner automatically resumes operation in about 3 minutes. Wait for it to restart.

■ Lightning

- If lightning may strike the neighboring area, stop operation and turn the breaker off for system protection.

■ Disposal requirements

- Dismantling the unit, and treatment of refrigerant, oil, and other parts, should be done in accordance with the relevant local and national regulations.

Troubleshooting

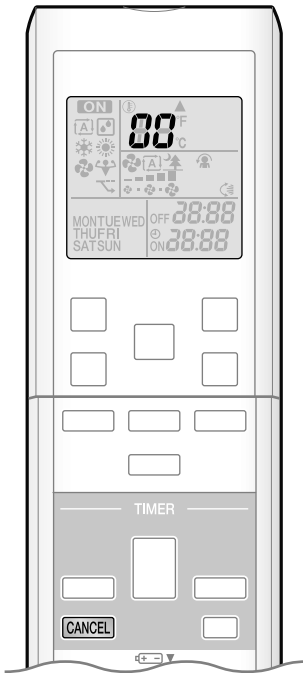

■ Fault diagnosis by remote controller

- The remote controller can receive a corresponding error code from the indoor unit.

1. When **CANCEL is held down for 5 seconds, a “00” indication blinks on the temperature display section.**

2. Press **CANCEL repeatedly until a continuous beep is produced.**

- The code indication changes as displayed in the following table, and notifies with a long beep.

	CODE	MEANING
SYSTEM	00	NORMAL
	UA	INDOOR-OUTDOOR UNIT COMBINATION FAULT
	U0	REFRIGERANT SHORTAGE
	U2	DROP VOLTAGE OR MAIN CIRCUIT OVERVOLTAGE
	U4	FAILURE OF TRANSMISSION (BETWEEN INDOOR UNIT AND OUTDOOR UNIT)
INDOOR UNIT	A1	INDOOR PCB DEFECTIVENESS
	A5	HIGH PRESSURE CONTROL OR FREEZE-UP PROTECTOR
	A6	FAN MOTOR FAULT
	C4	FAULTY HEAT EXCHANGER TEMPERATURE SENSOR
	C9	FAULTY SUCTION AIR TEMPERATURE SENSOR
OUTDOOR UNIT	EA	COOLING-HEATING SWITCHING ERROR
	E1	CIRCUIT BOARD FAULT
	E5	OL STARTED
	E6	FAULTY COMPRESSOR START UP
	E7	DC FAN MOTOR FAULT
	E8	OVERCURRENT INPUT
	F3	HIGH TEMPERATURE DISCHARGE PIPE CONTROL
	F6	HIGH PRESSURE CONTROL (IN COOLING)
	H0	SENSOR FAULT
	H6	OPERATION HALT DUE TO FAULTY POSITION DETECTION SENSOR
	H8	DC CURRENT SENSOR FAULT
	H9	FAULTY SUCTION AIR TEMPERATURE SENSOR
	J3	FAULTY DISCHARGE PIPE TEMPERATURE SENSOR
	J6	FAULTY HEAT EXCHANGER TEMPERATURE SENSOR
	L4	HIGH TEMPERATURE AT INVERTER CIRCUIT HEATSINK
L5	OUTPUT OVERCURRENT	
P4	FAULTY INVERTER CIRCUIT HEATSINK TEMPERATURE SENSOR	

NOTE

- A short beep and two consecutive beeps indicate non-corresponding codes.
- To cancel the code display, hold **CANCEL** for 5 seconds. The code display also cancel itself if the button is not pressed for 1 minute.

■ MEMO

Quick Reference

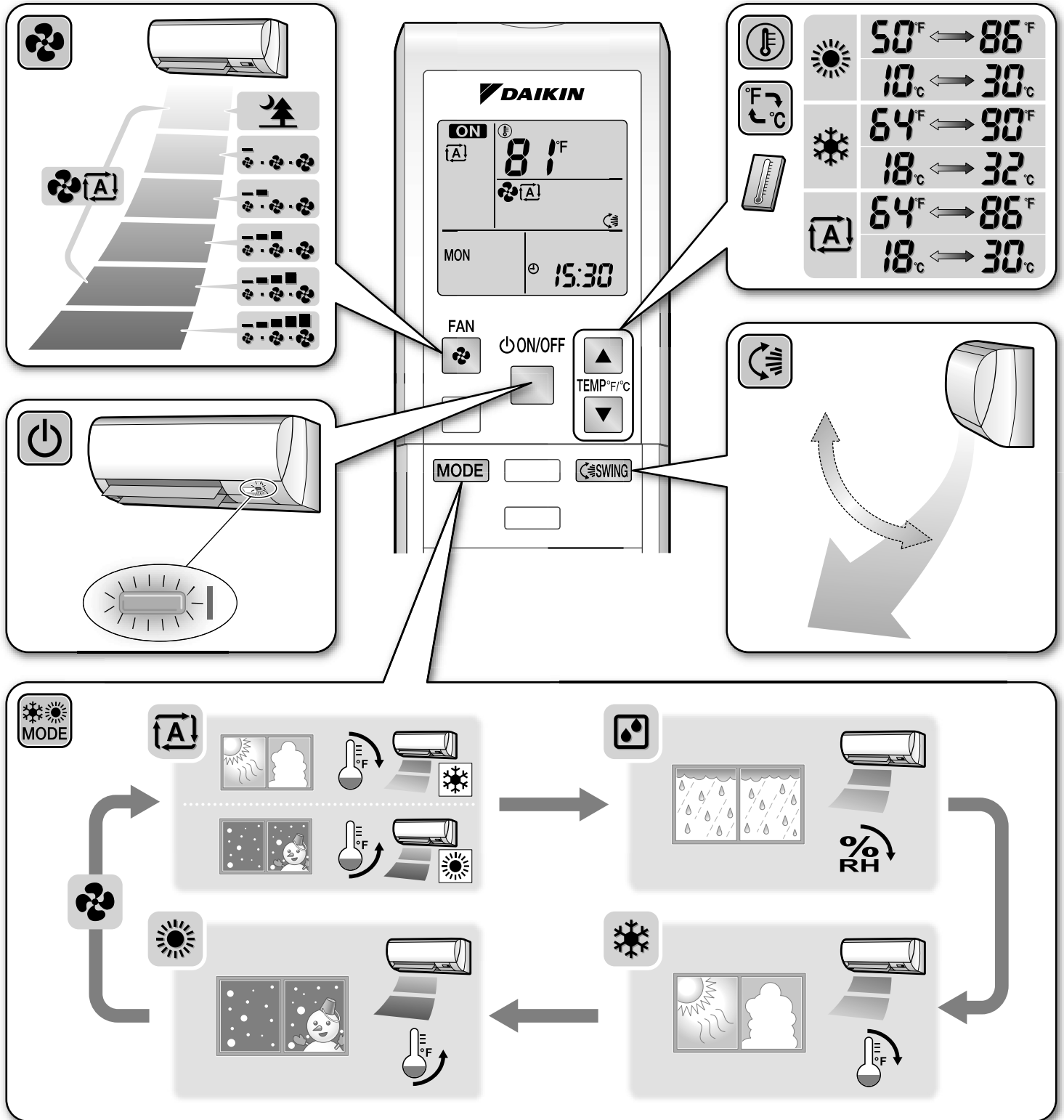

DAIKIN INDUSTRIES, LTD.

Head office:
 Umeda Center Bldg., 2-4-12, Nakazaki-Nishi,
 Kita-ku, Osaka, 530-8323 Japan

Tokyo office:
 JR Shinagawa East Bldg., 2-18-1, Konan,
 Minato-ku, Tokyo, 108-0075 Japan
http://www.daikin.com/global_ac/



Two-dimensional bar code is a code for manufacturing.

66162758 3P253185-1 M09B034 (0911)HT